

# WIRING DIAGRAM

## ER 100 I

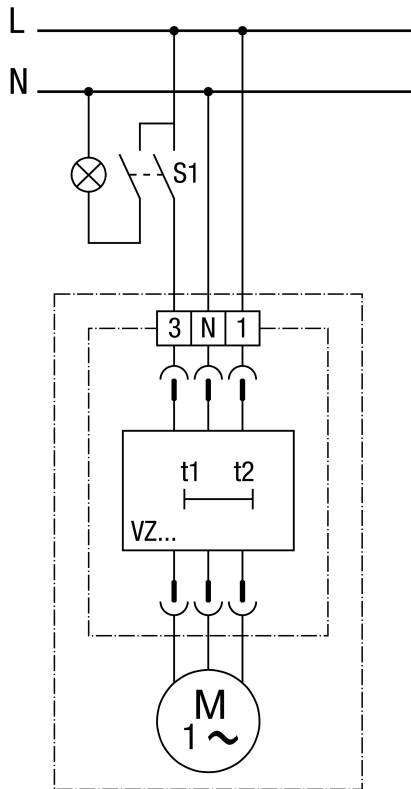

S1 on (after approx. 50 s)

S1 off (overrun time 6 min.)

Using a 1-pin switch can cause reverse polarity voltages. Combination with an X2 capacitor necessary!

# WIRING DIAGRAM

## ER 100 I



### Switching option 1



S1 and S2 on (after aprox. 50 s)

S1 off (overrun time 6 min.)

In addition, the fan can be switched off with switch S2 independent of the room lighting.

Using a 1-pin switch can cause reverse polarity voltages. Combination with an X2 capacitor necessary!